

Built-in Duplex Multiplexer & Pan/Tilt Control 14" COLOR OBSERVATION SYSTEM

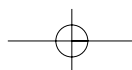



- **Built-in Duplex Multiplexer**
- **Built-in Pan/Tilt Control**
 - **Real-Time Display**
 - **LIVE/PB Digital Zoom**

Owner's Manual



SAFETY INFORMATIONS

These symbols with supplemental markings are at the rear of the monitor

	CAUTION RISK OF ELECTRIC SHOCK DO NOT OPEN	
CAUTION : TO REDUCE THE RISK OF ELECTRIC SHOCK, DO NOT REMOVE COVER, NO USER-SERVICEABLE PARTS INSIDE. REFER SERVICING TO QUALIFIED SERVICE PERSONNEL.		

■ Explanation of Symbols



The lightning flash with arrowhead symbol, with an equilateral triangle, is intended to alert the user to the presence of uninsulated "dangerous voltage" within the product's enclosure that may be of sufficient magnitude to constitute a risk of electric shock to persons.



The exclamation point within an equilateral triangle is intended to alert the user to the presence of important operating and maintenance (servicing) instructions in the literature accompanying the product.

WARNING : TO REDUCE THE RISK OF FIRE OR ELECTRIC SHOCK, DO NOT EXPOSE THIS UNIT TO RAIN OR MOISTURE.

NOTE : This equipment has been tested and found to comply with the limits for a Class A digital device, pursuant to part 15 of the FCC Rules. These limits are designed to provide reasonable protection against harmful interference when the equipment is operated in a commercial environment. This equipment generates, uses, and can radiate radio frequency energy and, if not installed and used in accordance with the instruction manual, may cause harmful interference to radio communications. Operation of this equipment in a residential area is likely to cause harmful interference in which case the user will be required to correct the interference at his own expense.

The user may find the following booklet prepared by the Federal Communications Commission helpful :

HOW TO IDENTIFY AND RESOLVE RADIO-TV INTERFERENCE PROBLEMS.

This booklet is available from the US Government Printing Office, Washington, DC 20402, Stock Number004-000-00345-4

CAUTION : CHANGES OR MODIFICATIONS NOT EXPRESSLY APPROVED BY THE PARTY RESPONSIBLE FOR COMPLIANCE COULD VOID THE USER'S AUTHORITY TO OPERATE THE EQUIPMENT.

SAFETY INSTRUCTIONS

■ Warning! Important Safety Instructions

1) Read Instructions

All the safety and operating instructions should be read before the appliance is operated.

2) Retain Instructions

The safety and operating instructions should be retained for future reference.

3) Heed Warnings

All warnings on the product and in the operating instructions should be adhered to.

4) Follow Instructions

All operating and use instructions should be followed.

5) Cleaning

Unplug this product from the wall outlet before cleaning. Do not use liquid cleaners or aerosol cleaners. Use a damp cloth for cleaning the unit.

Exception: A product that is meant for uninterrupted service and that for some specific reason, such as the possibility of the loss of an authorization code for a CATV converter, is not intended to be unplugged by the user for cleaning or any other purpose, may exclude the reference to unplugging the product in the cleaning description otherwise required in 5).

6) Attachments

Do not use attachments not recommended by the product manufacturer as they may cause hazards.

7) Water and Moisture

Do not use this product near water, for example near a bath tub, wash bowl, kitchen sink, or laundry tube in a wet basement or near a swimming pool and the like.

8) Accessories

Do not place this product on an unstable cart, stand, tripod, bracket or table.

The product may fall, causing serious injury to a child or adult, and serious damage to the product. Use only with a cart, stand, tripod, bracket or table recommended by the manufacturer, or sold with the product. Any mounting of the product should follow the manufacturer's instructions, and should use a

mounting accessory recommended by the manufacturer.

9) An product and cart combination should be moved with care. Quick stops, excessive force, and uneven surfaces may cause the product and cart combination to overturn.

Portable cart warning



10) Ventilation

Slots and openings in the cabinet are provided for ventilation and to ensure reliable operation of the product and to protect it from overheating and these openings must not be blocked or covered. The openings should never be blocked by placing the product on a bed, sofa, rug or other similar surface. This product should not be placed in a built-in installation such as a bookcase or rack unless proper ventilation is provided or the manufacturer's instructions have been adhered to.

11) Power Sources

This product should be operated only from the type of power resource indicated on the marking label. If you are not sure of the type of power supply to your home, consult your appliance dealer or local power company. For products intended to operate from battery power or other sources, refer to the operating instructions.

12) Grounding or Polarization

This product is equipped with a polarized alternating-current line plug (a plug having one blade wider than the other.) This plug will fit into the power outlet only one way. This is a safety feature. If you are unable to insert the plug fully into the outlet, try reversing the plug. If the plug should still fail to fit, contact your electrician to replace your obsolete outlet. Do not defeat the safety purpose of this polarized plug.

SAFETY INSTRUCTIONS

Alternate Warnings

This product is equipped with a three-wire grounding-type plug a plug having a third (grounding) pin. This plug will only fit into a grounding-type power outlet. This is a safety feature. If you are unable to insert the plug into the outlet, contact your electrician to replace your obsolete outlet. Do not defeat the safety purpose of the grounding-type plug.

13) Power-Cord Protection

Power-supply cords should be routed so that they are not likely to be walked on or pinched by items placed upon or against them paying particular attention to cords at plugs, convenience receptacles, and the point where they exit from the product.

14) Protective Attachment Plug

The product is equipped with an attachment plug having overload protection. This is a safety feature. See instruction Manual for replacement or resetting of protective device. If replacement of the plug is required, be sure the service technician has used a replacement plug specified by the manufacturer that has the same overload protection as the original plug.

15) Outdoor Antenna Grounding

If an outside antenna or cable system is connected to the product, be sure the antenna or cable system is grounded so as to provide some protection against voltage surges and built-up static charges. Article 810 of the National Electrical Code. ANSI/NFPA 70, provides information with regard to proper grounding of the mast and supporting structure, grounding of the lead-in wire to an antenna discharge unit, size of grounding conductors, location of antenna-discharge unit, connection to grounding electrodes, and requirements for the grounding electrodes. See Figure 1-1.

16) Lightning

For added protection for this product during a lightning storm, or when it is left unattended and unused for long periods of time, unplug the product from the wall outlet and disconnect the antenna or cable system. This will prevent damage to the product due to lightning and power line surges.

17) Power Lines

An outside antenna should not be located in the vicinity of overhead power lines or other electric light or power circuits, or where it can fall into such power lines or circuits. When installing an outside antenna system, extreme care should be taken to keep from touching such power lines or circuits as contact with them may be fatal.

18) Overloading

Do not overload wall outlets, extension cords, or integral convenience receptacles as this can result in a risk of fire or electric shock.

19) Object and Liquid Entry

Never push objects of any kind into this product through openings as they may touch dangerous voltage points or short out parts that could result in a fire or electric shock. Never spill liquid of any kind on the receiver.

20) Servicing

Do not attempt to service this product yourself as opening or removing covers may expose you to dangerous volt-age or other hazzards. Refer all servicing to qualified service personnel.

21) Damage Requiring Service

Unplug the product from the wall outlet and refer service opening to qualified service personnel under the following conditions:

- a)when the power-supply cord or plug is damaged,
- b)if liquid has been spilled, or objects have fallen into the product,
- c)if the product has been exposed to rain or water.
- d)if the product does not operate normally by following the operating instructions. Adjust only the controls that are covered by the operating instructions as an improper adjustment of other controls may result in dam-age and will often require extensive work by a qualified technician to restore the video product to its nor-mal operation.
- e)If the product has been dropped or damaged in any way, and
- f)When the product exhibits a distinct change in performance - this indicates a need for service.

SAFETY INSTRUCTIONS

22) Replacement Parts

When replacements parts are required, be sure the service technician has used replacements parts specified by the manufacturer or have the same characteristics as the original part. Unauthorized substitutions may result in fire, electric shock or other hazards.

23) Safety Check

Upon completion of any service or repairs to this receiver, ask the service technician to perform safety checks to determine that the product is in proper operating condition.

24) Wall or Ceiling Mounting

The product should be mounted to a wall or ceiling only as recommended by the manufacturer.

25) Heat

The product should be situated away from heat sources such as radiators, heat registers, stoves, or other products (including amplifiers) that produce heat.

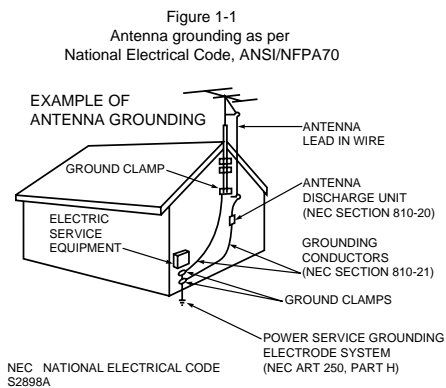

CONTENTS

INTRODUCTION	1
MONITOR SYSTEM PART NAME	
▪ FRONT PANEL	2
▪ BACK PANEL	3
MULTIPLEXER SYSTEM OPERATION	
▪ STARTING THE SETUP MODE	4
▪ MAIN MENU	4
▪ SUB MENU SETTING	5
CAMERA INPUT	5
CHANNEL TITIE	5
DATE / TIME	6
AUTO SWITCH	6
REC TYPE	7
ALARM/LOSS	7
ALARM/LOSS LIST	8
OBSERVATION CAMERA OPERATION	
CAMERA PART	9
CAMERA INSTALLATION	9
PAN/TILT DOME CAMERA OPERATION	
CAMERA PART	10
CAMERA INSTALLATION	10
REMOTE CONTROL UNIT	11~12
SYSTEM OPERATION	
STANDARD CAMERA OPERATION	13
MULTIPLE STANDARD CAMERA OPERATION	13
OBSERVATION CAMERA TWO WAY INTERCOM INSTALLATION	14
OBSERVATION CAMERA ALARM DEVICE INSTALLATION	14
PAN/TILT DOME CAMERA OPERATION	15
MULTIPLE PAN/TILT DOME CAMERA OPERATION	15
MULTIPLE SYSTEM OPERATION	16
BNC CAMERA SYSTEM OPERATION	16
AUXILIARY OPERATION	
INSTALLATION	17
VCR OPERATION	17~18
ALARM OPERATION	19~21
VIDEO LOSS	21
SPECIFICATION	
14" BUILT-IN MUX COLOR MONITOR	22
MULTIPLEXER	23
CAMERA (PAN/TILT DOME COLOR CAMERA)	24
CAMERA (OBSERVATION COLOR CAMERA)	25
ACCESSORIES	26
USER'S GUIDE	27~28
TROUBLE SHOOTING GUIDE	29

PRIOR TO USE

■ PRIOR TO USE

This is the basic manual for Built-in Mux Control 14" Color Observation System user. The content of this manual is focused on product introduction, installing method, connecting method with other devices, using method of various functional buttons, and system setting method with the setup menu.

Before using this equipment, this manual should be read not only by first users, but also by the users who are already familiar with this system or any other similar device in accordance with the precautions stated within the manual.

Before getting started with this equipment, it should be emphasized that the user must consult and receive help from the dealer where the product was purchased when opening the case and fixing the internal parts of the system for upgrade or repair.

And also if you have any further questions related to using this equipment or think you have a problem with the product, please consult your dealer.

■ UNPACKING

Upon purchase of this system, unpack the box and put the unit on a floor stand, or place the unit where you are going to install the system. Please check the contents of the package as listed below.

■ IN CASE of Observation system

- Monitor main unit
- Observation Camera (or Pan/Tilt Dome Camera)
- 20m(60ft) Multi(Din or RJ-11) Cable
- Instruction Manual
- Power Cable
- Remote Controller (Optional)

■ IN CASE of Only Monitor

- Monitor main unit
- Instruction Manual
- Power Cable

INTRODUCTION

This equipment will give you added security and comfort for many years. It is easy to install in almost anywhere you need audio/video surveillance. To safely use all the high technical functions of the unit, please read the installation and operating instruction in manual, and keep it for the future reference. Also, it can directly control Pan/Tilt Dome Camera without any extra controller.

FUNCTIONS

- **Built-in Real Time 4 channel Color Duplex Multiplexer**
- **Built-in Auto Switcher**
- **Built-In Digital Multi Comb Filter (NTSC/PAL)**
- **Built-In Pan/Tilt Dome Camera Control (Multi <Din, RJ> Jack)**
- **Built-In Camera Vertical GEN-Lock (Multi <Din, RJ> Jack)**
- **Multi System (NTSC/PAL)**
- **Alarm In/Out & Two Way Talk**
- **Horizontal Resolution 420TV Lines**
- **Free Voltage (AC 100V ~ 240V, 50/60Hz)**
- **On Screen Menu Control & Digital Picture Menu Control**

MONITOR SYSTEM PART NAME

Front Panel

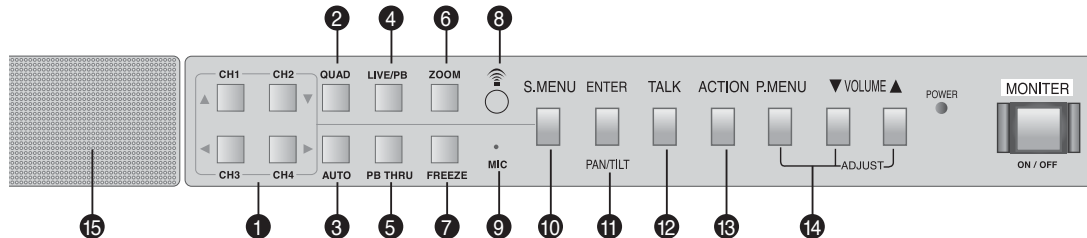

1 CHANNEL SELECT BUTTONS

- In Live / PB mode : When desired channel button is pressed, a full screen of the channel is displayed.
- Menu(S.MENU) mode
 - ▲▼ Button : To move throughout each item of the Main Menu or that of the sub menu to set it up.
 - ◀▶ Button : To increase or decrease the value of each item.
- Pan/Tilt Dome Camera Control

2 QUAD

Quad Screen display in LIVE or PB.

3 AUTO

Sequentially switching the channel in only LIVE MODE

4 LIVE/PB

Switching the LIVE Mode or Play Back Mode.

5 PB THRU

Monitoring the recorded multiplexer OUT signal or Playback signal of TIME LAPSE VCR.

6 ZOOM

Zooming the special part of the screen in 2 Times, pressing the button again, the screen will be larger 2 Times, and then move the highlighted area by using the arrow buttons (▲,▼,◀,▶).

7 FREEZE

When a Full screen in selected and user presses the "FREEZE" button, the screen will be frozen, and the alphabet "F" will be displayed on to the selected channel. If user presses the button once more, the Freeze will be deactivated. When a Quad screen is selected, if a user presses the "FREEZE" button and desired channel button, then the selected channel screen will be frozen.

8 IR RECEIVER

Receiving the remoon signal.

9 MIC

MIC input when pressed only TALK button in the channel selected.

10 S.MENU(SYSTEM MENU)

If user presses this button, it will display the setup menu. User can change the various functional settings of this system from the setup menu. Use the arrow buttons(▲▼◀▶) to move from menu to menu, or change the value of the sub menu.

11 ENTER / PAN/TILT

- Menu(system set-up) mode : When the modification of each Sub Menu item is complete, press this button to save the settings. Use this button to enter a Sub Menu of the Main Menu or to return to the Main Menu from Sub Menu by pressing this button on "EXIT"
- Pan/Tilt On/Off button. Assuming that Pan/Tilt dome camera is connected to any channel, if user selects the channel and presses this button, the Pan/Tilt control mode will be started. And using the arrow buttons (▲▼◀▶), user can freely control the Pan/Tilt dome camera to its taste. (If a user uses more than two Pan/Tilt dome camera, each pressing the Pan/Tilt button will select from CH1 to CH4, to control the each camera.)

12 TALK

Press and hold this button to talk through to the camera and release it to receive.

13 ACTION

This button can lock or release the door open, or activate other alarm device. It will be used to remotely open a door, or activate different kinds of detectors. (Send only trigger signal)

14 P. MENU (PICTURE MENU)

- Each pressing this button in VCR and Live mode, the Sub Menu will sequentially displayed on to the screen. Use volume buttons(▲▼) to adjust each Sub menu and press P. Menu button to deactivate.
- Contrast : Use to adjust the contrast of the screen.
- Brightness : Use to adjust the brightness of the screen.
- Color : Use to adjust the density of color.
- Tint : Use to adjust the tint of color.(NTSC only)
- Sharpness : Use to adjust the sharpness of color.

15 SPEAKER

MONITOR SYSTEM PART NAME

Back Panel

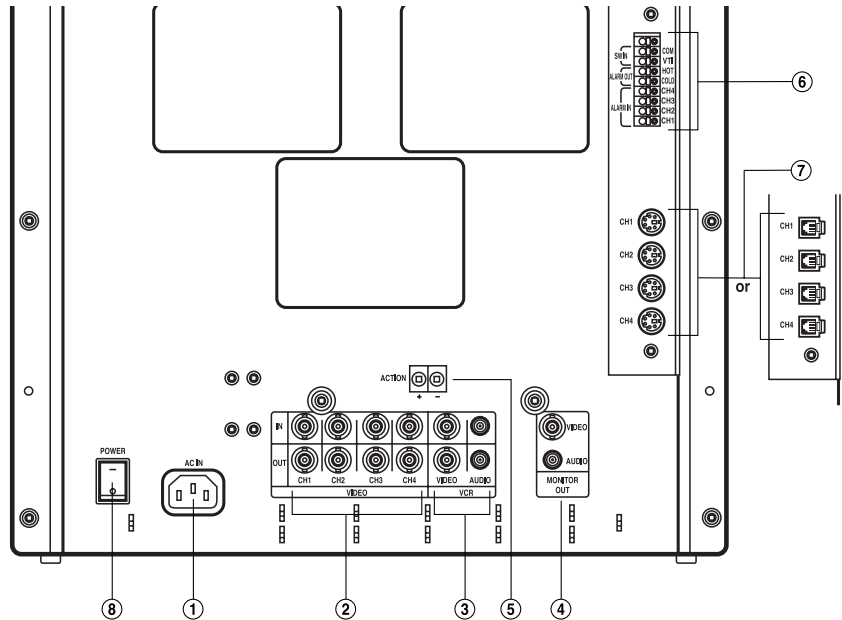

1 AC INPUT

This is an input terminal that connects to AC 100~240V power.

2 VIDEO INPUT/OUTPUT CONNECTORS

- BNC camera inputs 1~4 : These inputs are used for standard cameras with BNC type connectors.
- Looping outputs 1~4 : These are looping outputs for cameras on through. It can be used to display or record the pictures on a separate monitor or recorder.

3 VCR VIDEO/AUDIO INPUT/OUTPUT CONNECTORS

Video/Audio input connectors are for receiving video/audio signal from VCR or another video unit.
Video/Audio output connectors are for transmitting video/audio signal from a camera to another monitor. Also used in recording on VCR.

4 MONITOR VIDEO/AUDIO OUTPUT CONNECTORS

Video/Audio output for slave monitor. Connect via double male to double male RCA leads of required length.
NB : Maximum recommended distance between master and slave monitor is 20m.

5 ACTION TERMINAL

To activate several kinds of detectors, such as Door Lock and Alarm Device.

6 ALARM TERMINAL

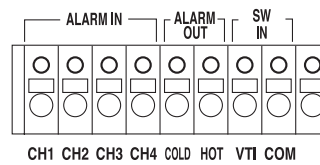

7 CAMERA INPUT MULTI(DIN) JACKS

To connect to 4 cameras, such as our Pan/Tilt Dome Camera and general Observation Camera.

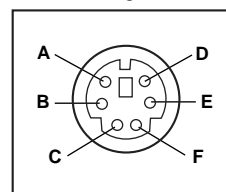

- A) +12V
- B) Audio in
- C) CAPW (Camera auto amp)
- D) Video in
- E) Audio out (Alarmin)
- F) V-sync (Gen-lock)

CAMERA INPUT RJ JACKS

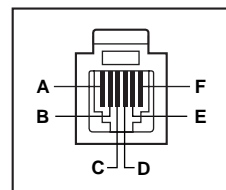

- A) Alarm + Gen Lock
- B) B+ (DC 15V)
- C) Audio out + Pan/Tilt
- D) Video in
- E) Audio in
- F) GND

8 MAIN POWER SWITCH

MULTIPLEXER SYSTEM OPERATION

This chapter shows you how to execute various modes using the system setup menu.

STARTING THE SETUP MODE

1. Check the power cables of the equipment connected to Monitor and turn the power switch.

2. Press the S. Menu button on the front panel.

Note

Only while in Live Mode, you can enter the setup mode.

2001 / 09 / 24	14:12:38
LOSS	LOSS
CH01 S	CH02
LOSS	LOSS
CH03	CH04

MAIN MENU

Press the “S. MENU” button on the front of the system, the main menu of the system setup appears as follows.

[MAIN MENU]
1. CAM INPUT SET
2. CH_TITLE SET
3. DATE/TIME SET
4. AUTO SWITCH SET
5. REC TYPE SET
6. ALARM/LOSS SET
7. ALARM/LOSS LIST
EXIT : S. MENU

• **Modifying settings**

Select a menu item by using the ▲ ▼ buttons and press ENTER and then you find the SUB Menu and you can change the setup by press the direction Key (▲,▼,◀,▶)

• **Saving the Setting / Returning to the Main Menu**

When the modification of each sub menu item is complete, press the Enter button to save the settings. Use this button to enter a Sub Menu of the Main Menu or to return to the Main Menu from Sub Menu, placed the cursor on “EXIT”.

MULTIPLEXER SYSTEM OPERATION

SUB MENU SETTING

1. CAMERA INPUT SET

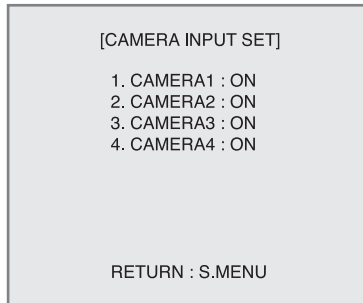

- Set channel [ON], if camera is connected to the channel, and set channel [OFF] if camera is not connected to the channel.

- If the channel is set to [OFF], missing video input signals are not treated as LOSS.

- From the <MENU>, set the cursor on the 1. CAMERA INPUT SET item using ▲ and ▼ keys, and press ENTER key. [CAMERA INPUT SET] screen will be displayed.

- In the screen, set the cursor on the channel to configure using ▲ and ▼ keys, select using ◀ or ▶ key, and set the channel status ON or OFF using ▲ and ▼ keys. Pressing the S MENU key takes the user to the previous menu (<MENU>).

2. CHANNEL TITLE

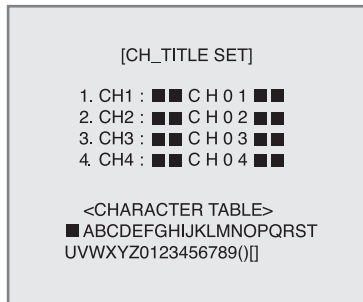

- Enter the title of each channel.

- In <MENU>, set the cursor on the 2.CH_TITLE SET item using ▲ and ▼ keys, then press ENTER key. [CH_TITLE] screen appears.
- Use ▲ and ▼ keys to select, use ◀ and ▶ keys to move and select desired alphabet, and select the alphabet from the character table using ▲ and ▼ keys.

MULTIPLEXER SYSTEM OPERATION

3. DATE/TIME SET

```
[DATE/TIME SET]
1. DATE FORM : 1
  <1>DD/MM/YYYY
  <2>MM/DD/YYYY
  <3>YYYY/MM/DD
2. DATE : 2001/07/07
3. TIME : 00/00/00

RETURN : S.MENU
```

- Setting up date and time

- 1. DATE FORM: (1) : Select one of the following appropriate date forms to display date.

<1>DD/MM/YYYY : Day / Month / Year

<2>MM/DD/YYYY : Month / Day / Year

<3>YYYY/MM/DD : Year / Month / Day

- Set the cursor on the 3.DATE/TIME SET using ▲, and ▼ keys from the <MAIN MENU>, and then press ENTER key. [DATE/TIME SET] screen appears.
- Press ▲ or ▼ key to move the cursor up and down.
- To setup date form, select one among <1>, <2> and <3> date forms using ◀ or ▶ keys and change the date form using ▲ and ▼ keys depending on the date display convention of each country.
- To setup date, set the cursor on the date using ▲ and ▼ keys, then move to the field to change using ◀ and ▶ keys, and set the value using ▲ and ▼ keys.
- To set up time, set the cursor on the time using ▲ and ▼ keys, then move to the field to change using ◀ and ▶ keys, and set the value using ▲ and ▼ keys.
- To escape from current setting mode, press S MENU key.
- If a user want to record the Time & Date on the picture, a user should have "Display On" of its Time lapse VCR turned on, because this system does not support Time & Date on display in recording mode.

4. AUTO SWITCH SET

```
[AUTO SWITCH SET]
1. CH1 : 03SEC
2. CH2 : 03SEC
3. CH3 : 03SEC
4. CH4 : 03SEC
5. QUAD : 03SEC

RETURN : S.MENU
```

- Set the CHANNEL DWELL TIME for AUTO SWITCH operation.

- You can set the time within the range of 0 to 30 second.

From the <MENU>, set the cursor on the 4.AUTO SWITCH SET using ▲ and ▼ keys, and press ENTER key. [AUTO SWITCH] screen appears.

- Set the cursor on the appropriate channel using ▲ and ▼ keys, select using ◀ and ▶ keys, and set using ▲ and ▼ keys.
- When DWELL TIME setting is completed, press the S MENU key to return to the MAIN MENU screen.

MULTIPLEXER SYSTEM OPERATION

5. REC TYPE SET

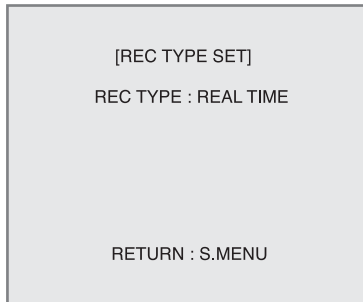

- Allows setting of the recording mode of TIME LAPSE VCR to be connected with MULTIPLEXER.
 - Set the cursor on the 5.REC TYPE SET using ▲ and ▼ keys, and press ENTER key to enter the SUB MENU on the right.
 - To record intermittently, locate the cursor on the 1. TIMELAPSE using ▲ and ▼ keys, and press ENTER key.
To record in 60 fields/sec (NTSC standard) or 50 fields/sec (PAL standard), select 2. REAL TIME and press ENTER key.
 - In case of TIME LAPSE record mode, connect SW TRIGGER signal from VCR to the TERMINAL SW IN of main unit, connect GND signal to COM, and connect SW-OUT signal to VT1.
- If the connection is not properly established, only the signal from a certain camera is not recorded.
- If the VCR's record time setting is something other than the TIME LAPSE mode, signals from 4 cameras may not be recorded properly.

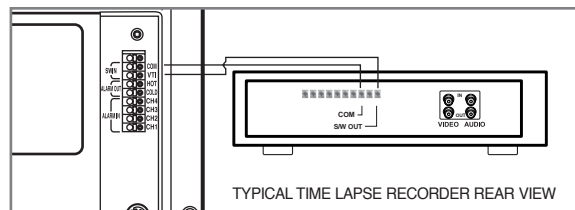

- In case of REAL TIME record mode, camera signal output is automatically switched by fields regardless of the SW TRIGGER signal from the VCR.
- In case of TIME LAPSE record mode, camera signal output is automatically switched by field or frame of the SW TRIGGER signal from the TIME LAPSE VCR.
- Switch out timing of TIME LAPSE VCR must be selected frame.
If switch out timing of TIME LAPSE VCR is selected field, the recording image missed some fields.
- Press the S MENU key to return to the MAIN MENU.

6. ALARM/LOSS SET

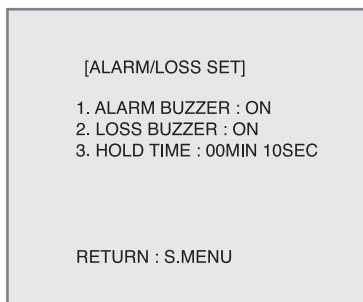

- ALARM / LOSS BUZZER SET-UP
 1. ALARM : Set BUZZER ON/OFF when ALARM occurs.
 2. LOSS : Set BUZZER ON/OFF when LOSS occurs.
 3. HOLD TIME: Time to continue ALARM state after ALARM occurs.
- From the <MENU>, set the cursor on the 6. ALARM/LOSS SET using ▲ and ▼ keys, and press ENTER. [ALARM/LOSS SET] screen appears. Set the cursor on the setting entry using ▲ and ▼ keys and set or change the values in the entry using ◀ and ▶ keys.
- In [ALARM/LOSS SET] screen, configure 3. HOLD TIME to 5 seconds interval for the first second to the first minute, and 1 minute interval for the first minute to the 30th minute, as described above.

MULTIPLEXER SYSTEM OPERATION

7. ALARM / LOSS LIST

- To view up to 10ALARM/LOSS history records,
From the <MENU>, set the cursor on the 7. ALARM/LOSS LIST using the ▲ and ▼ keys, and press ENTER.
[ALARM / LOSS LIST] screen appears as illustrated below. If the number of occurred ALARM/LOSS exceeds the limit (10), the latest item replaces the oldest items.

[ALARM/LOSS LIST]				
NO	DATE	TIME	T	CH
01	2001/08/24	03:23:10	L	03
02	2001/08/24	08:25:30	A	01
		⋮		
10	2001/08/24	09:00:00	A	02
RETURN : S.MENU				

No.1 LOSS occurred in camera No.3 at August 24th 2001 3:23:10 a.m.

No.2 ALARM occurred in sensor No.1 at August 24th 2001 8:25:40 a.m.

No.10 ALARM occurred in sensor No.2 at August 24th 2001 9:00:00 am.

- Press the (DELETE) TALK key to delete all history records. Please confirm the records to delete before delete them.
- Press ENTER key to return to the [ALARM/LOSS SET] screen.
- To return to MAIN MENU, press the S.MENU button.

OBSERVATION CAMERA OPERATION

CAMERA PART

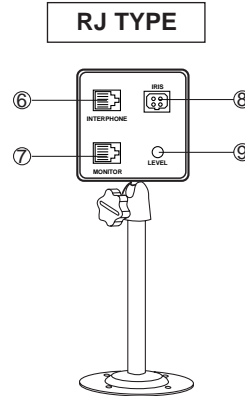
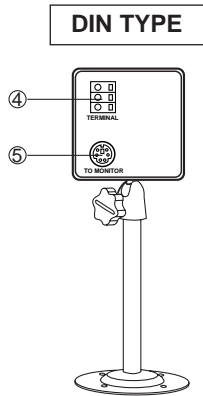
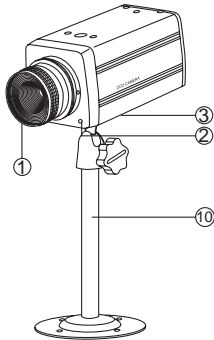

1. CCD CAMERA LENS

Deliver sharp image to the CCD sensor.

2. MICROPHONE

Pick up sound around the camera.

3. SPEAKER

Delivers the sound from the monitor

4. ALARM TERMINAL

Connect an optional alarm device to this terminal.

5. MONITOR INPUT JACK

Din connect the cable with the monitor.

6. INTERPHONE

7. MONITOR INPUT JACK

RJ-11 Connector cable to the monitor.

8. DC IRIS LENS CONNECTOR

When using on DC iris lens.

9. LEVEL

Auto DC iris type video level control.

10. BRACKET

IN	○ □	IN ≠ Alarm input (normally open)
GND	○ □	GND ≠ Ground
B+	○ □	B+ ≠ Power output +12V DC 100mA
TERMINAL		

●Permanent installation using pedestal stand.

<p>1. Attach the Pedestal using 4 screws.</p>	<p>2. Attach the Camera onto the Pedestal and tighten the screw.</p>

CAUTION : Keep camera installed away from direct sunlight. Also avoid places where humidity is high or where the camera is not protected from rain. The mounting bracket must be attached to a structural object such as a wall stud or ceiling rafter using suitable fastener. Do not touch the glass of the lens. This could damage the delicate coating on its surface. If the lens has to be cleaned, use a special lens cleaning tissue available at any good camera store.

PAN/TILT DOME CAMERA OPERATION

■ CAMERA PART

Electrical power is not connected to the dome and observation / quad monitor during installation.

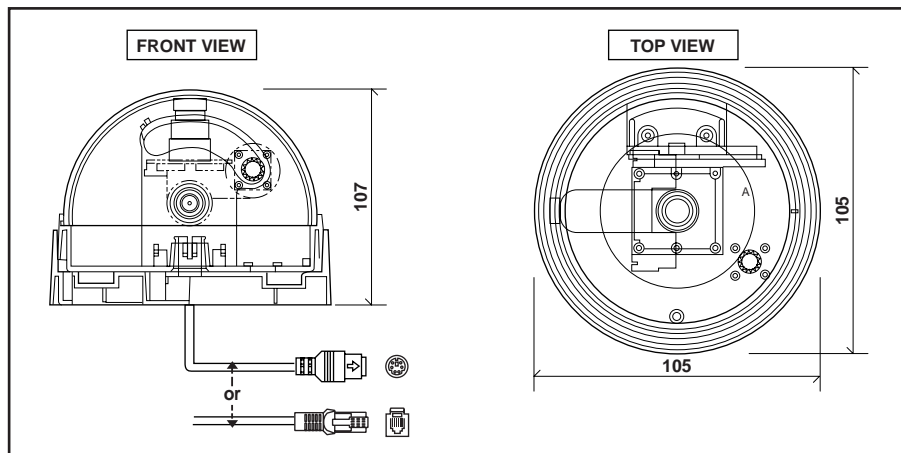

■ CAMERA IN STALLATION

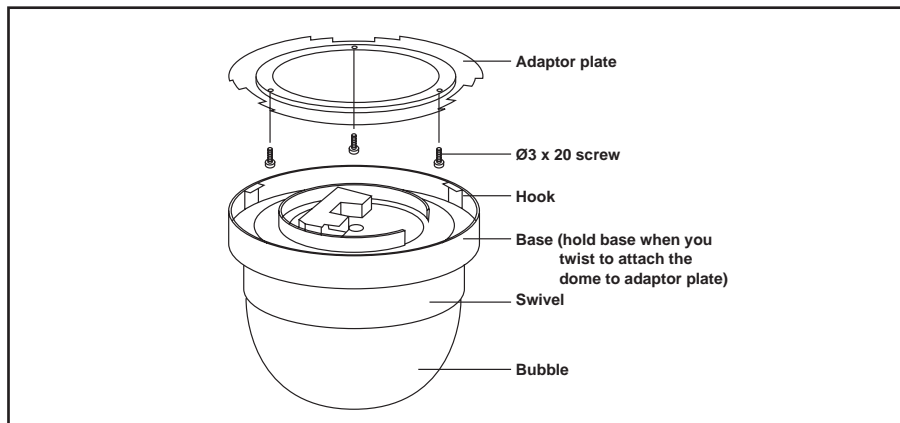

Be sure that no power is connected to dome camera and observation / quad monitor during installation.

1. Twist open the clear dome cover to CCW to reach inside the dome camera.
2. Place the controller on the desk or proper appropriate location.
3. Connect the controller and the observation / quad monitor with 10ft din cable. (Included in the package of controller)
4. Wiring the 60ft din cable from controller to dome camera.
5. Attach the adaptor plate on the ceiling. Using Ø3 X 20 screws (included)
6. Twist the base of the dome camera to the adaptor plate on the ceiling.



Do not hold clear bubble or swivel, when you attach the dome to adaptor plate.

7. Attach one end of DIN connector to the back of the control unit's connector. (named camera)

※Repeat sequence 1 through 7 until install all dome cameras.

REMOTE CONTROL UNIT

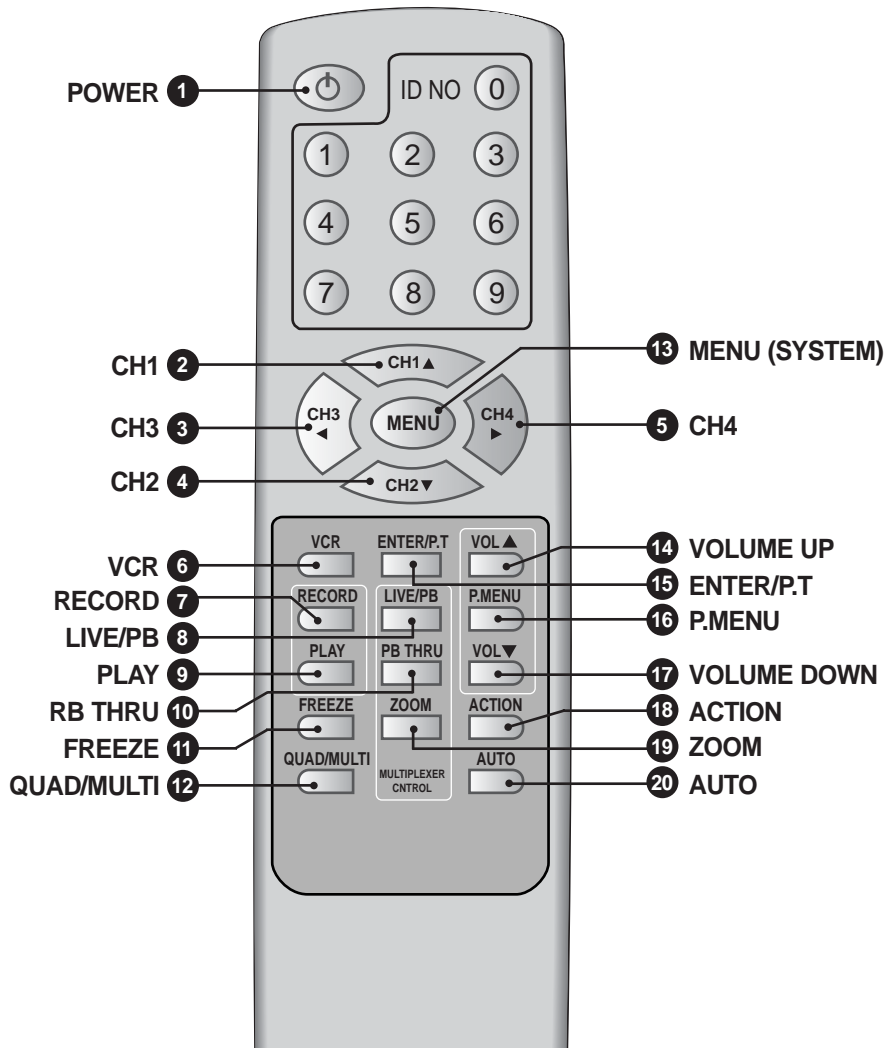

※ This remote control unit is commonly used in various model.
Some keys are not available in the special model.

CAUTION

**Danger of explosion if battery is incorrectly replaced.
Replace only with the same or equivalent type
recommended by the manufacturer.
Dispose of used batteries according
to the manufacture's instructions.**

REMOTE CONTROL UNIT

- 1 POWER**
Press to turn the MONITOR on and off.
- 2 CH1 (▲)**
CH1 button enables the camera 1 to be displayed in a single mode.
- 3 CH2 (▼)**
CH2 button enables the camera 2 to be displayed in a single mode.
- 4 CH3 (◀)**
CH3 button enables the camera 3 to be displayed in a single mode. Also used to highlight selections on the system main menus.
- 5 CH4 (▶)**
CH4 button enables the camera 4 to be displayed in a single mode.
Also used to highlight selections on the system main menus.
- 6 VCR**
Press this button to display the picture of VCR playback.
- 7 RECORD**
Used in the built-in Quad monitor only.
- 8 LIVE/PB**
Used in the Mux monitor only
- 9 PLAY**
Press this button to display the picture of VCR playback.
- 10 RB THRU**
Used in the Mux monitor only
- 11 FREEZE**
Press this button to stop the image temporarily.
- 12 QUAD/MULTI**
Used in the quad display monitor only
- 13 MENU(SYSTEM)**
Display the system main menu on the screen.
You can set up CAM INPUT SET, CH_TITLE SET, DATE/TIME SET, AUTO SWITCH SET, REC TYPE SET ALARM/LOSS SET and ALARM/LOSS LIST.
- 14 VOLUME UP**
Press to increase the volume level. Also used to select items on the on-screen picture menu.
- 15 ENTER/P.T**
If this key is pressed, the system goes to the PAN/TILT control mode, and then you can change the camera view position by pressing the up/down, right/left button.
- 16 P.MENU (PICTURE MENU)**
Display the Picture Menu on the screen.
You can set up CONTRAST, BRIGHTNESS, COLOR, TINT(NTSC only) and SHARPNESS.
- 17 VOLUME DOWN**
Press to decrease the volume level. Also used to select items on the on-screen picture menu.
- 18 ACTION**
It switches the internal relay to put on.
- 19 ZOOM**
Zoom in on the picture in LIVE MODE &PLAY BACK MODE.
- 20 AUTO**
This button makes the quad processor switched the signal sources to be displayed sequentially.

■ INSERTING THE BATTERIES IN THE REMOTE CONTROLLER

You must insert or replace the batteries in the remote controller when you:

- Purchase the set. (AAA size 1.5V × 2)
- Find that the remote controller is no longer operating correctly.

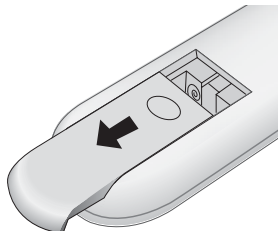

- 1** Remove the cover of the remote controller by pressing the symbol and pulling the cover space in the direction of the arrow.

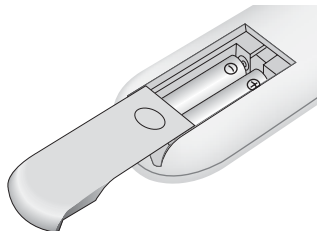

- 2** Insert 2 batteries(AAA size), taking care to respect the polarities.

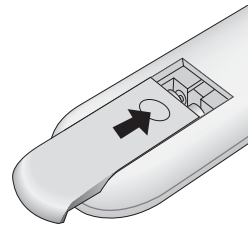

- 3** Replace the cover by pushing it in the direction of the arrow.

! You can use your remote controller within a distance of 7~10m and an angle of 30 degrees from the left and right sides of the remote controller receptor of your monitor.

SYSTEM OPERATION

STANDARD CAMERA OPERATION

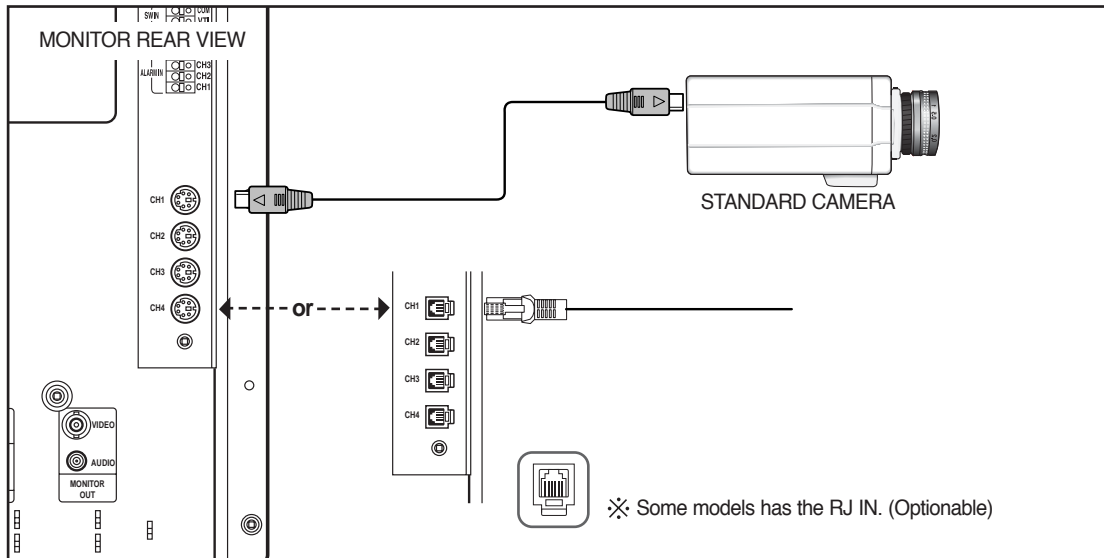

STANDARD CAMERA INSTALLATION

MULTIPLE CAMERA OPERATION

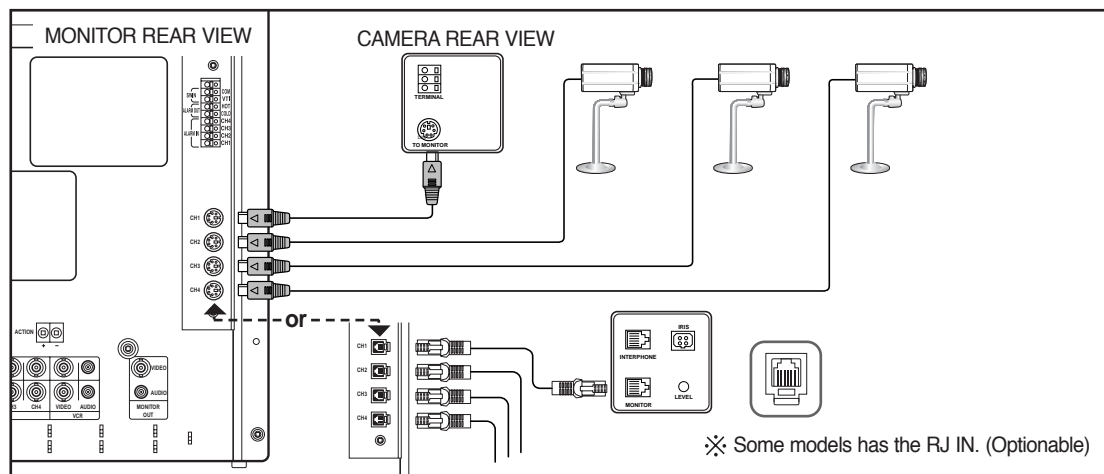

MULTIPLE CAMERA INSTALLATION

1. Connect all camera cables and verify operation, as shown above.
(You should plug out while you connect additional cameras).
Each channel is exclusive with same NO of BNC Input.
2. When you push the auto button, monitor goes to auto switching mode.

SYSTEM OPERATION

■ OBSERVATION CAMERA TWO WAY INTERCOM INSTALLATION

● Camera with intercom installation

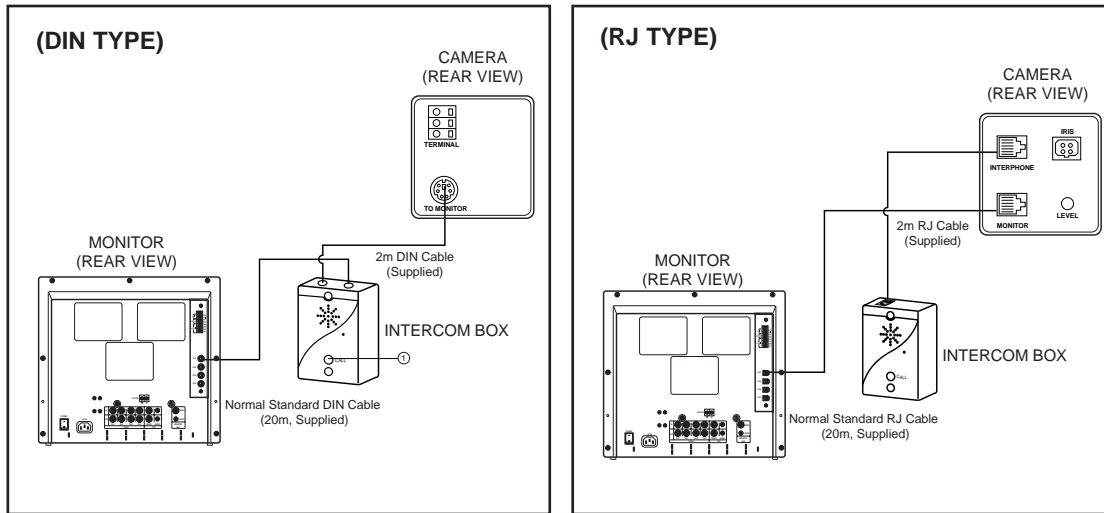

① DOORBELL : There is a push button on the intercom box, which can be used as a doorbell when the button is pushed, a buzzer will sound at the monitor after which the pictures is switched to the corresponding camera.

● NOTE : Do not use telephone cable or other special cable. If the provided camera cable is not long enough or Additional and longer cables can be purchased from your distributor.

■ OBSERVATION CAMERA ALARM DEVICE INSTALLATION

● Camera with alarm device installation

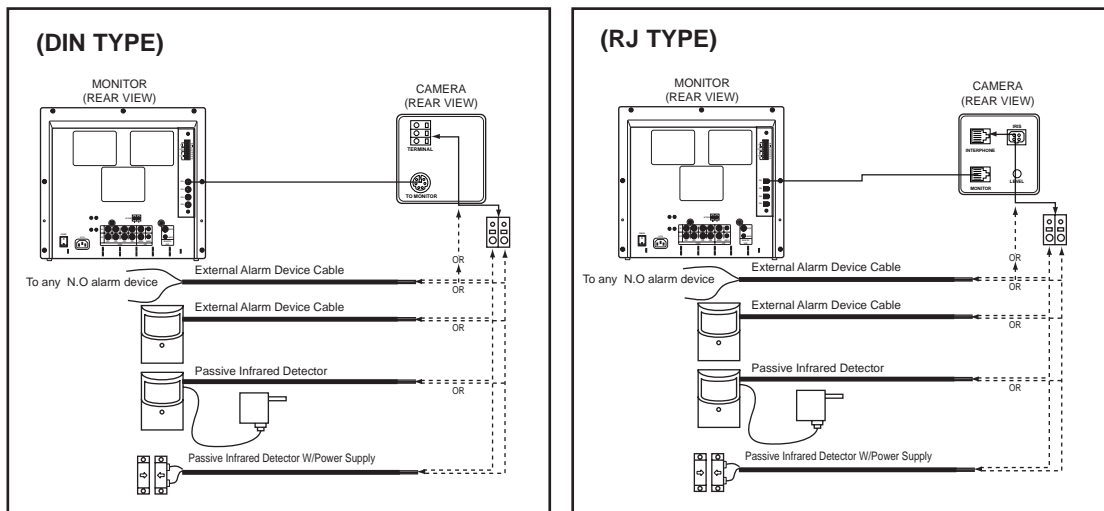

SYSTEM OPERATION

PAN/TILT DOME CAMERA OPERATION

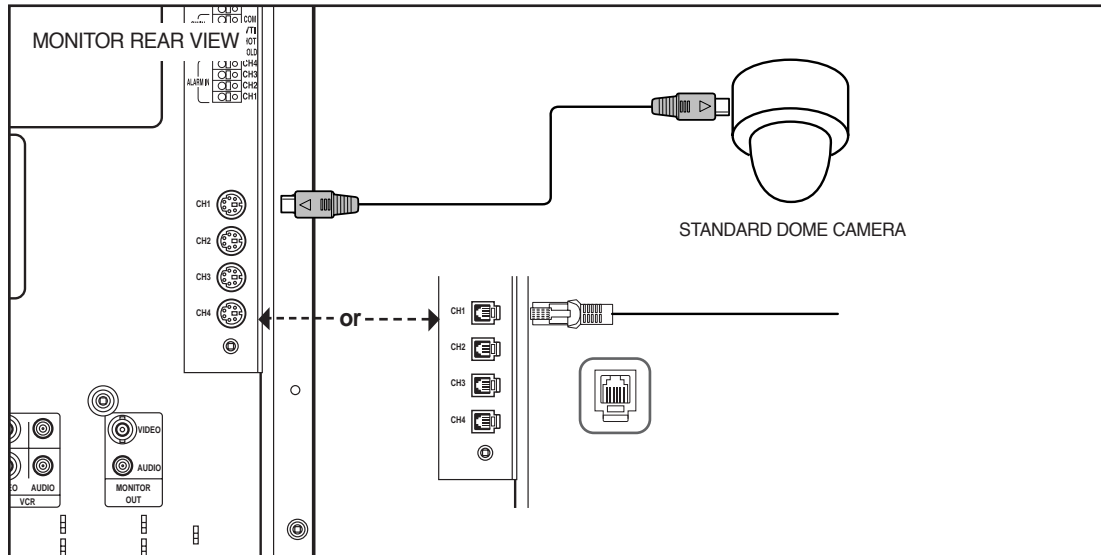

PAN/TILT DOME CAMERA INSTALLATION

MULTIPLE PAN/TILT DOME CAMERA OPERATION

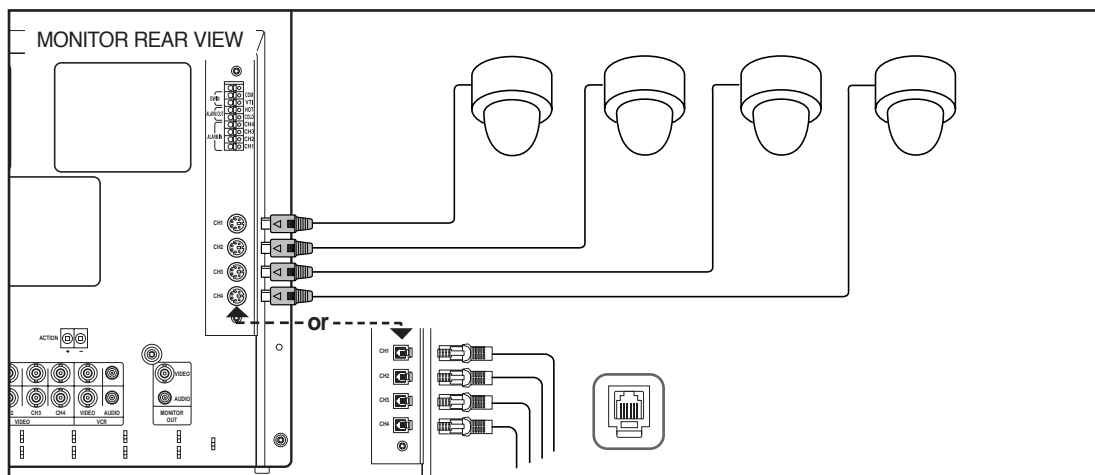

MULTIPLE PAN/TILT CAMERA INSTALLATION

1. Connect all camera cables and verify operation, as shown above.
(You should plug out while you connect additional cameras).
Each channel is exclusive with same NO of BNC Input.
2. When you push the auto button, monitor goes to auto switching mode.

SYSTEM OPERATION

■ MULTIPLE SYSTEM OPERATION

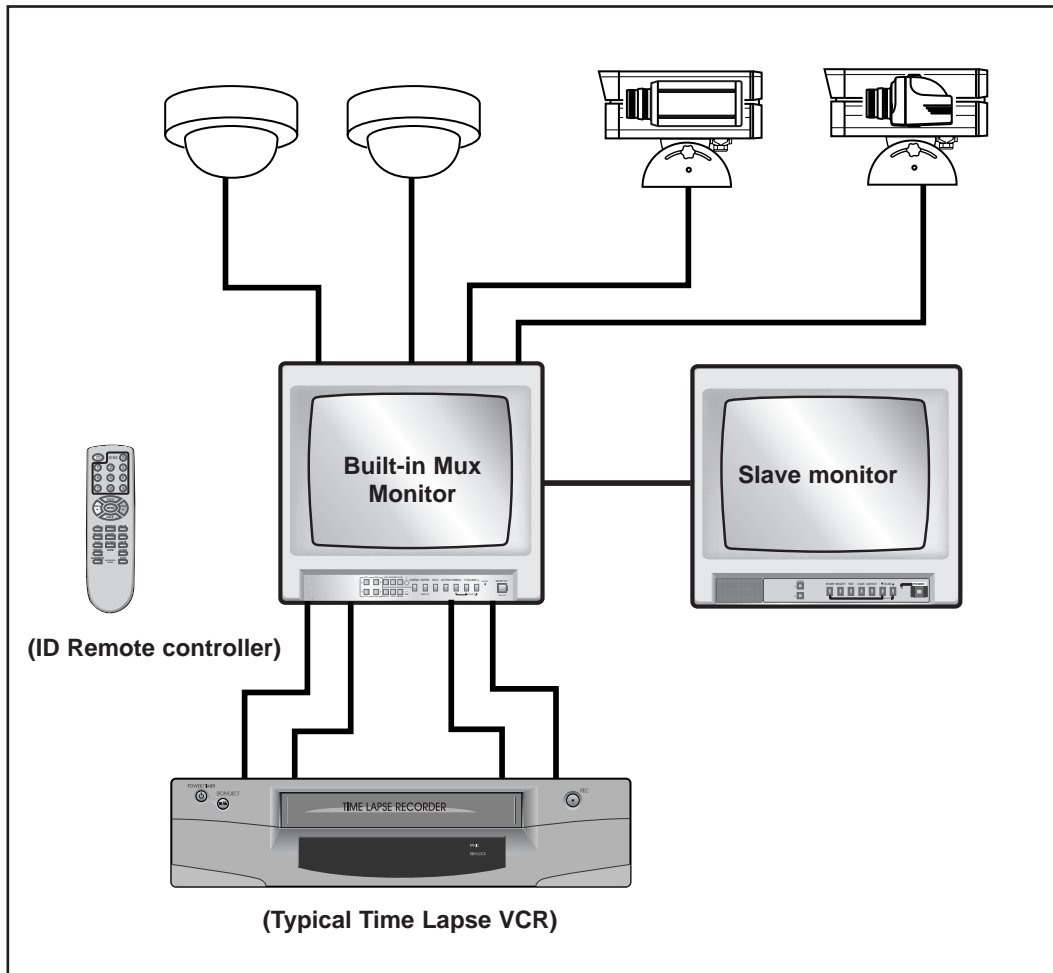

■ BNC CAMERA SYSTEM OPERATION

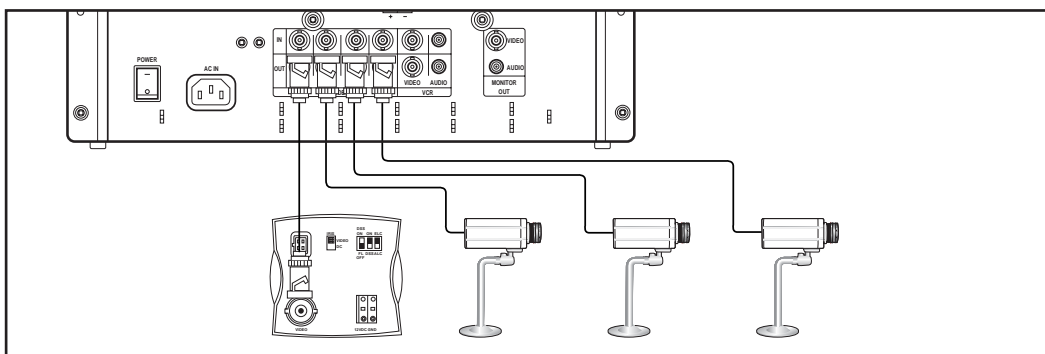

AUXILIARY OPERATION

INSTALLATION

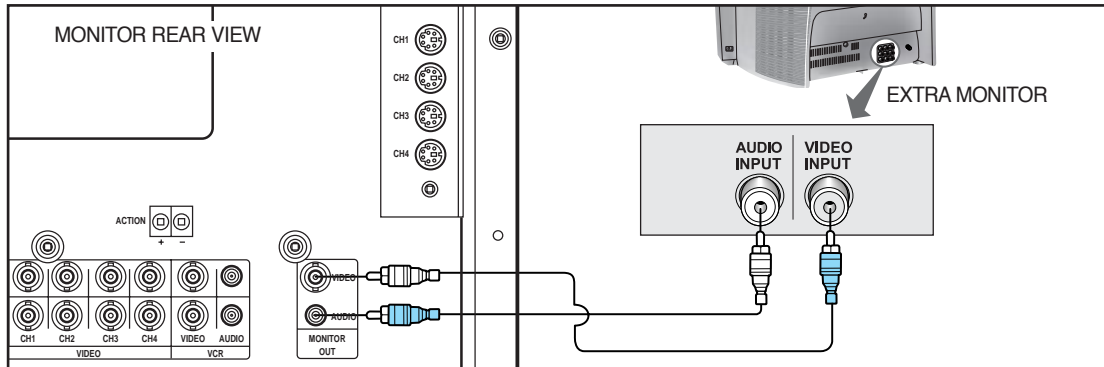

EXTRA MONITOR INSTALLATION

VCR OPERATION

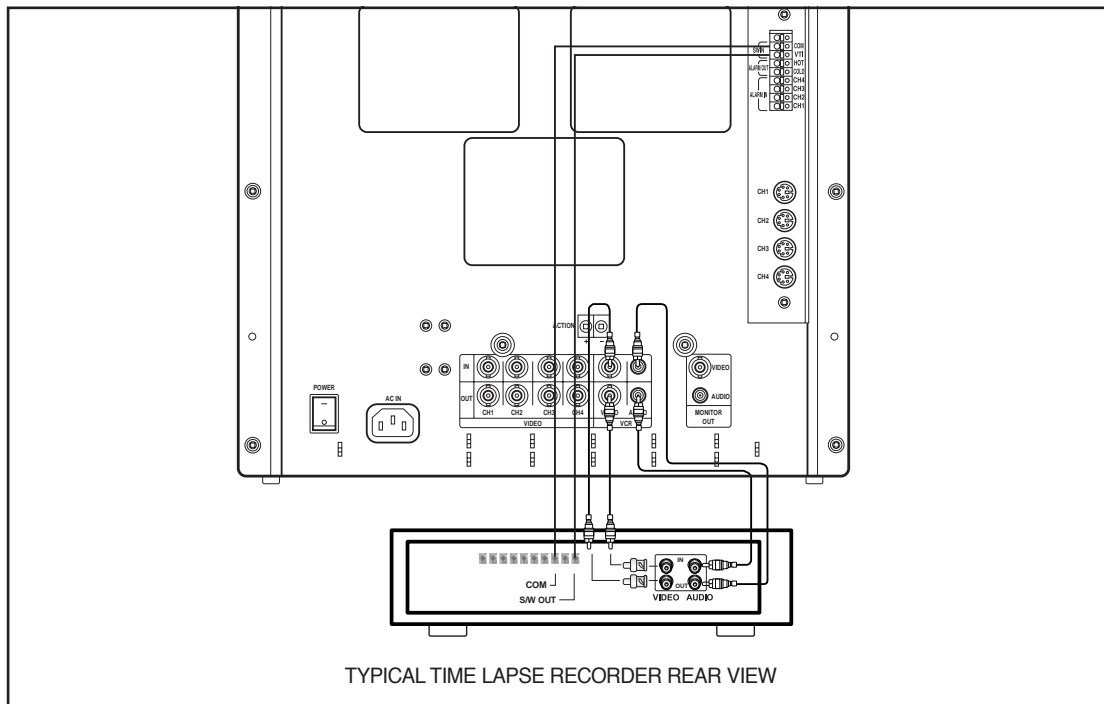

OBSERVATION MONITOR WITH A RECORDER

1. In case of TIMELAPSE record mode, connect SW TRIGGER output signal from VCR to the TERMINAL SW IN of main unit, connect GND signal to COM, and connect SW-OUT signal to VTI. If the connection is not properly established, only the signal from a certain camera may be recorded. If the VCR's record time setting is something other than the TIMELAPSE mode, signals from 4 cameras may not be recorded properly.

AUXILIARY OPERATION

2. In case of REAL TIME record mode, camera signal output is automatically switched by fields regardless of the SW TRIGGER signal from the VCR.
In case of TIME LAPSE record mode, camera signal output is automatically switched by field or frame of the SW TRIGGER signal from the TIME LAPSE VCR.
Switch out timing of TIME LAPSE VCR must be selected frame.
If switch out timing of TIME LAPSE VCR is selected field, the recording image missed some fields.
 3. Then, press the "**REC**" button on the VCR.
 4. To play back, press the "**PLAY**" button on the VCR and press the **PB** KEY on the monitor at the same time.
 5. Verify that the monitor is displaying a good picture from the camera and make a test recording to verify operation of the VCR.
 6. Your system is now ready to do observation recording.
- * When you are operating the normal VCR, make sure the VCR is in Line or AV Mode.

AUXILIARY OPERATION

ALARM OPERATION

A. Monitor Alarm Circuit

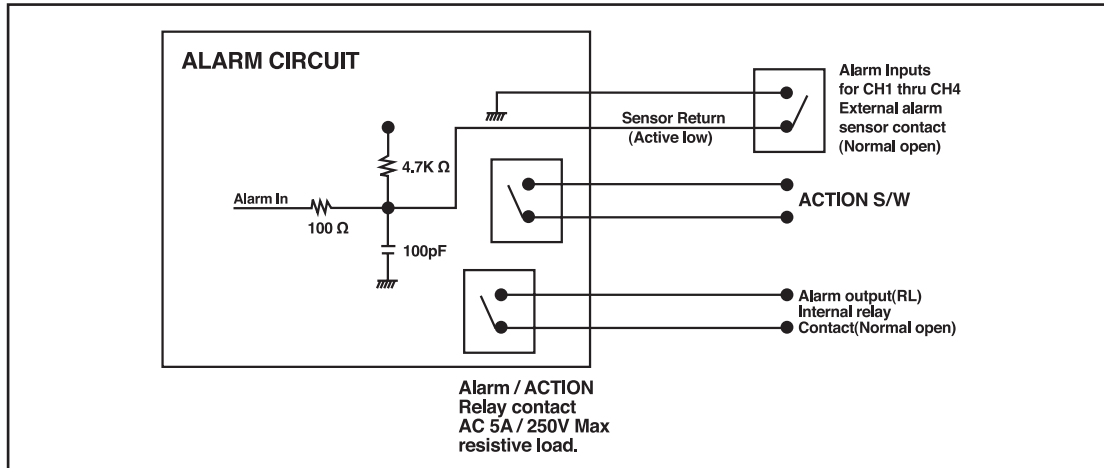

MONITOR ALARM CIRCUIT

B. Alarm Connection There are two ways to connect with alarm. One is to connect with terminal Block on the back panel of monitor and the other is with AUX port on rear panel of camera.

B-a. Terminal Block Connection

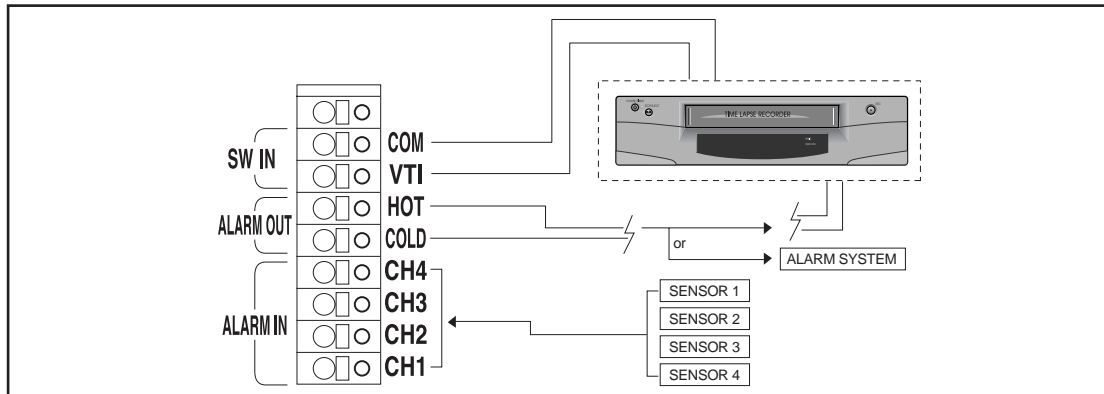

ALARM DEVICE INSTALLATION (In case of using TIME LAPSE VCR)

1. SW IN
 - GND : This is the COMMON Ground for ALARM OUT & IN.
 - VTI : This is the Trigger Input from the Time Lapse VCR for changing the channel for multiplexing recording.
2. ALARM OUT
 - HOT/COLD : This is the ALARM OUT for the Time Lapse VCR or ALARM system. (This terminal is normally open)
 - If the alarm is occurred, this terminal is switched to closed. ("ACTIVE MAKE")
3. ALARM IN
 - CH1~CH4 : These terminals are assigned to each camera alarm sensor or the special alarm system.
 - The alarm sensor must be normally open type.

AUXILIARY OPERATION

C. ALARM OPERATION

When an alarm is activated, the associated camera video displays full screen, the word ALARM displays on screen, a buzzer, if programmed "30 SEC", generates a continuous audible alarm for 30 seconds and the alarm output relay activates.

If the second or third sensor is activated while the first alarm is operating, the screen will switch to the second or third sensing camera. Pressing the **VCR KEY** resets the alarm condition.

*When connected to a time lapse VCR, the VCR will automatically switch to the normal mode when an alarm is sensed. If the VCR was programmed (ex:24hrs, 72hrs then the VCR will automatically switch back once the alarm is released.

(1) ALARM INPUT specification (Normally in "H" state due to FULL UP resistance of the MULTIPLEXER itself.)



(2) ALARM OUT specification.

The points of contact of RELAY are used as output (HOT/COLD, no polarity), and the points of contact are open (NORMAL OPEN) during normally. However, the points of contact are closed (MAKE) during HOLD TIME resulted from ALARM occurred.

The specification of points of contact is 5A 250VAC (Avoid connecting with the product that has higher capacity than the specification).

(3) When a single ALARM occurs

If BUZZER is set "ON" from the ALARM/LOSS MENU, then BUZZER sounds.

To cancel ALARM, press any one of CH1~4, QUAD, AUTO, LIVE/PB, ZOOM, PB THRU, and FREEZE keys. ALARM is canceled even if ALARM HOLD TIME is in progress.

The date, time and channel ALARM occurred are stored in the ALARM/LOSS LIST.

BUZZER sounds during ALARM HOLD TIME specified in ALARM MENU. ALARM and BUZZER sound continues until the time set in HOLD TIME is reached.

If ALARM occurs while you are viewing in single screen or automatic serial switching is in progress, single screen switches to QUAD screen. Even if ALARM is cancelled by pressing key or the expiration of HOLD TIME, QUAD screen does not return to the original status.

(4) When multiple ALARMS occur.

If ALARM occurs while you are viewing in single screen or automatic serial switching is in progress, single screen switches to QUAD screen. Even if ALARM is cancelled by pressing key or the expiration of HOLD TIME, QUAD screen does not return to the original status.

"A"(For ALARM) mark is displayed on the channel where the ALARM occurred during HOLD TIME.

Other channels where ALARM occurred are also indicated by "A" mark and a new HOLD TIME begins since the last ALARM occurred.

If ALARM occurs during setting the MENU, the MENU setting status is cancelled, and it performs Alarm operation first. When HOLD TIME is expired, the channel where ALARM occurred is displayed.

(5) RECORD OUT when ALARM occurs.

If ALARM occurs in channel 1 or 3, "A" mark blinks at the bottom of the channel screen in QUAD screen.

The frequency of the alarmed channel is increased in record out so that the channel is more frequently recorded

AUXILIARY OPERATION

(near real-time recording).

e.g., If ALARM occurred in ALARM SENSOR 1 interoperating with camera 1, the order of record out would be :
1 - 2 - 1 - 3 - 1 - 4 - 1 - 1 - 2 - 1 - 3 - 1 - 4 - 1 - 1 - 2.....

When ALARM is cancelled by pressing key or the expiration of HOLD TIME, the frequency of channel recording is returned to the original status.

If ALARM occurs during PB, screen is turned to QUAD screen automatically.

VIDEO LOSS

A built-in video loss detection system generates a visual alarm if video is lost from any of the four camera inputs. If video is lost from a camera, the screen goes blank and LOSS appears on the screen. Unaffected cameras continue to display video.

1) CHANNEL LOSS operation

According to the selection of ON/OFF in ALARM/LOSS MENU.,if the signal is lost,
,you can hear the Buzzar sound & the screen will be changed to blue back display.
,of course the channel without signal displays the blue back screen.

And the information of Loss channel is memorized in ALARM/LOSS LIST.

In case of single channel or during the switching automatically, if the ALARM is occurred
,the screen is changed to QUAD display mode. At this time in case of canceling the ALARM
the QUAD screen is maintained.

2) Cancelling the LOSS operation

The LOSS operation is cancelled automatically by inputting the signal of CH1~4,QUAD,LIVE/PB
ZOOM,PB THRU,FREEZE KEY, and also the Buzzar sound disappear simultaneously.

In case of no signal, the time of ALARM operation depends on the setting of the ALARM
HOLD TIME.

And the blue back screen is maintained until the Loss operation is cancelled though the ALARM is
Cancelled in any other method.

3) In case of non-operation of LOSS BUZZAR

If the LOSS BUZZAR is set to OFF state in ALARM/LOSS MENU, the Buzzar sound is not
operated inspite of the channel without signal

The LOSS detection is not operated during the setting the MENU.

And the channel set to OFF state in CAMERA INPUT SET is cancelled LOSS and BUZZAR function.

In case of PB, if the LOSS is detected, the screen is changed to LIVE QUAD mode automatically.

SPECIFICATIONS

■ 14" BUILT-IN MUX COLOR MONITOR

System	NTSC	PAL
Picture Tube	14Inch CRT, 0.66mm stripe pitch, 90° deflection	
	Visible picture size 33.7cm(13inch) measured diagonally	
Horizontal Resolution	420 TV Lines	
Video In/Out	4 Composite In / Out (Through) (BNC), IVp-p with 75Ω termination	
	VCR PB IN (BNC), IVp-p with 75Ω termination	
	VCR REC Out (BNC), IVp-p with 75Ω termination	
	4 Camera Multi DIN Jack Input (or RJ Input Jack)	
Audio In/Out	1/2/3/4 (DIN or RJ), VCR (RCA), Monitor (RCA),	
	-5dBu, High Impedance	
Function Mode	4CH Auto Switching,	
	Alarm & Video Loss Detection , Action Switch.	
	Talk (2 Way)	
Sub Carrier Frequency Sync. Range	3.579545 MHz ± 500Hz	4.433618 MHz ± 500Hz
Horizontal Frequency Stability	15.75KHz ± 500Hz	15.625KHz ± 500Hz
Vertical Frequency Stability	60Hz ± 5Hz	50Hz ± 5Hz
High Voltage	24kV ± 1.0kV	
Speaker Power	1W Max	
Power Input	AC 100V ~ 240V (50Hz / 60Hz)	
Power Consumption	70W Max	
Dimension	365 x 339 x 391 (W x H x D) (mm)	
Weight	13kg	
Option	Wireless IR Remote Controller	

SPECIFICATIONS

MULTIPLEXER

System	NTSC	PAL
PIXCEL RESOLUTION	FULL : 720(H) × 480(V) QUAD : 360(H) × 240(V)	FULL : 720(H) × 586(V) QUAD : 360(H) × 286(V)
VCR TRIGGER IN	TTL Negative Pulse	
ALARM IN	TTL Negative Pulse Make Contact (4EA)	
ALARM OUT	Contact RELAY (Normal OPEN)	
ALARM HOLD TIME	1~30MIN (1MIN/PER) 1~60SEC (5SEC/PER)	
CHANNEL TITLE	EACH CHANNEL 8 CHARACTERS	
DATE/TIME	YYYY/MM/DD, MMDD/YYYY, DD/MM/YYYY HH/MM/SS	
ALARM INDICATION	"A"	
FREEZE INDICATION	"F"	
CHANNEL LOSS	BLUE BACK SCREEN or "L"	
DISPLAY	QUAD, SINGLE(FULL)	
AUTO SWITCHING	1 to 30 sec	
ALARM LOG	Up to 10 EVENTS	
POWER SOURCE	+12V (for AUDIO etc.) +5V (Main VIDEO & DIGITAL)	

SPECIFICATIONS

■ CAMERA (PAN/TILT DOME COLOR CAMERA)



System	NTSC	PAL
Power source	DIN : DC12V (From Monitor)	
	RJ : DC15V (From Monitor)	
Image sensor	1/3" Interline transfer CCD	
Active pixels	512(H) x 492(V)	512(H) x 582(V)
Image sensor area	4.8(H) x 3.7(V)mm	
Signal to noise	46dB	
Electronic IRIS	1/100,000 sec	
Synchronization	External	
Signal format	525 lines, 2:1 interface	625 lines, 2:1 interface
Video output	1.0V p-p (75 ohm)	
Audio output	600 Ohms line level	
Ambient temperature	-10°C ~ +50°C (14°F ~ 122°F)	
Ambient humidity	0 ~ 96% Non-condensing	
Image sensor	1/3" Color	
Resolution	> 330 TV lines	
Min. illumination	1 Lux	
Lens	4.3 or 3.6mm Fixed.	
Power consumption	Max 3.6W	
Panning angle	355°	
Pan/Tilt speed	15°/sec	
Tilting angle	80°	
Housing type	Indoor	
Weight	1Kg	

SPECIFICATIONS

■ CAMERA (OBSERVATION COLOR CAMERA)

System	NTSC	PAL
Pick-up device	1/3" or 1/4" color CCD	
No. of picture elements	512(H) x 492(V)	512(H) x 582(V)
Horizontal resolution	> 330 TVL	
Light sensitivity	3.5 ~ 30,000 Lux	
Spectral sensitivity range	400 ~ 1,000 nm	
Signal to noise ratio	> 48dB	
White balance	Auto TTL, 2,500 ~ 6,500°K	
Built-in microphone	Electric	
Speaker	0.3W	
Lens type	C/CS mount	
Lens viewing angle	59°H ~ 46°V	
Lens focal length	F1.2	
Lens min. illumination	1Lux	
Power supply	DIN : DC12V (From Monitor)	
	RJ : DC15V (From Monitor)	
Synchronization	Gen lock	
Alarm output	DIN : 3Pin terminals	
	RJ : RJ-11 Jack	
Power consumption	4W	
Temperature (operating/storage)	-10°C ~ +50°C / -25°C ~ +70°C	
Cabinet	Metal	
Weight	255g	

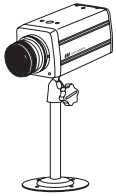
ACCESSORIES

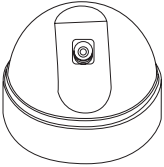
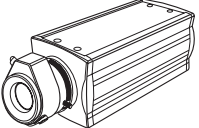
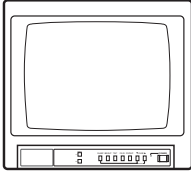
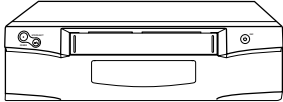
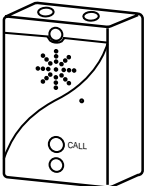
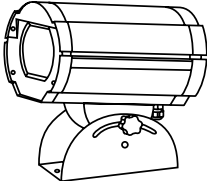
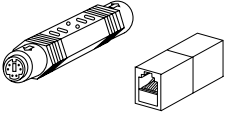
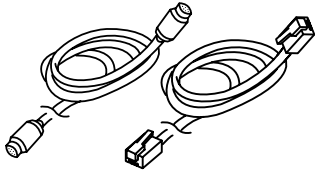
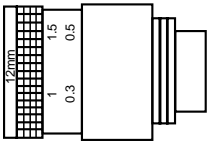
Additional camera available	Optional camera	Optional Pan/Tilt Dome camera
		
Day-night camera	Slave Monitor	VCR
		
Intercom Box	Weather proof housing	Extension connector jack
		
Extension cable	Wide angle lens (8mm / 12mm)	
		

USER'S GUIDE

1. RECORDING TO VCR

1) TIMELAPSE MODE

- Channel to be recorded is switched, whenever NEGATIVE SWITCHING PULSE through SW OUT port of TERMINAL arrives from TIME LAPSE VCR. Therefore, the interval of channel switching is determined by recording time of TIME LAPSE VCR. Since as the recording time increases, the time interval between channels to be recorded becomes longer so that the probability of missing important scene grows. Therefore the configuration of appropriate recording time is important.
- When ALARM occurs, the recording frequency of the alarmed channel is increased.
- If TIME LAPSE VCR is configured to very short time duration comes under REAL TIME MODE, recording might be out of order, and there might be some channels that are not recorded.

2) REAL TIME MODE

- If TIME LAPSE VCR is configured to time duration comes under REAL TIME MODE, channels are recorded in order in tape by FIELD SWITCHING of 60 fields/sec for NTSC, and 50 fields/sec for PAL.
- When ALARM occurs, the recording frequency of the alarmed channel is increased by recording weighting.
- If TIME LAPSE VCR is configured to time duration comes under TIME LAPSE MODE, recording might be out of order, and there might be some missing fields in recording.

2. PLAY BACK RECORDED TAPES

- When you play back tape using TIME LAPSE VCR, you have to choose appropriate PLAY TIME of TIME LAPSE VCR for the precise search of desired picture. If you play back tape, which recorded in long time mode, in short time mode, scenes will pass by so fast that you may not find desired scene easily. Therefore, search videotape for desired scene, changing time mode appropriately.
- To play back videotape, press PB THROUGH key to see playback signal status of TIME LAPSE VCR, and adjust pictures so that vertical turbulence and noise bar is not be displayed using + and - TRACKING buttons.
- Manipulate LIVE/PB key to turn off LED. Then video signals from each channel are displayed in order on the corresponding location in QUAD screen. To stop and see a standstill image, press FREEZE key, or PAUSE/STILL key of TIME LAPSE VCR.
- When playback is suspended using PAUSE/STILL key of TIME LAPSE VCR, you can view output from the VCR in the monitor using PB THRU key.
- Even if current screen is standstill by pressing FREEZE key, tape is being played back continuously. Therefore, the screen will display images of time passed when the frozen screen is released. To see missing images, you have to rewind the tape.
- Channel without signal is displayed by black screen during playback.
If the signal of a channel is missing during playback, the standstill image of last screen of the channel is displayed.
The standstill screen turns to black screen when the channel is selected again by pressing channel key and there is no signal at that time.

USER'S GUIDE

3. VIEWING FULL SCREEN

When the desired channel among the 4 buttons of "CH1, CH2, CH3, CH4" on the front side of Monitor is pressed, the selected channel appears in Full screen.

4. VIEWING QUAD SCREEN

If user presses the "Quad" button on the front side of Monitor, the Quad image appears.

5. VIEWING AUTO SEQUENCE TRANSITION SCREEN

The Auto Sequence Transition Screen mode enables user to switch between channels on one, quad, multi screen. This can be activated by pressing the "AUTO" button in Live mode
- If all channels do not have video signals the Auto Sequence button should not work.

TROUBLE SHOOTING GUIDE

While using the system, certain unexpected situations may cause problem with the system. In many cases, system trouble can be solved through a simple trouble shooting check.

If you encounter any problems using this system, please check the following points.

1. When the Power will not turn on Check whether the power cord is properly plugged in.
2. When the Power is on but the screen does not appear. Check whether the camera, monitor and output terminals are properly connected.
3. If the recording function does not work. Check whether the video in terminal of the VCR and the VCR out terminal of Monitor is properly connected. Check whether the tape is recordable.
4. When the recorded tape does not play. Check whether the video out terminal of the VCR and the VCR in terminal of Monitor are properly connected.

Note

When problems relating with recording/playing occur, you must check the conditions of the connected VCR. If you checked all of the above conditions and you still find problems, refer to your supplier and contact a technician.

Note

If you are not comfortably accustomed with the use of such systems, it is highly recommended for you to contact your supplier and directly ask for help.

IMPORTANT

Further charges may be incurred if this system is outside the guarantee period (in which case you will be sent a repair estimate), or if the repairs are not covered by the guarantee. PLEASE RETAIN ALL ORIGINAL PACKAGING IN THE EVENT THAT YOU NEED TO RETURN AN ITEM FOR SERVICE. THIS REDUCES THE RISK OF DAMAGE IN TRANSIT.

MEMO

MEMO

MEMO